

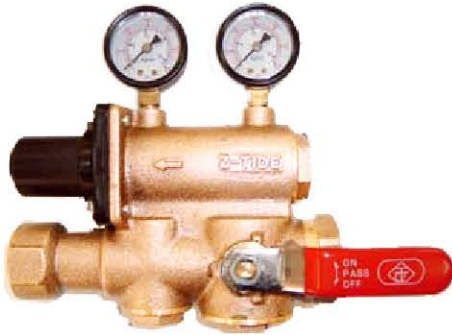

# PRESSURE REDUCING VALVE SET



- ▶ Module assembly, which means light structure, space-saving, easy installation and maintenance.
- ▶ Equipped with buffer check valve, unfavorable effect from water impulse can be eliminated.
- ▶ Simple structure, precise tuning and easy operation.
- ▶ Module assembly can decrease leakage coming from assembly connections due to long-term vibration.

(Thread end)

Item No	Type(PT)	L(mm)	H(mm)	Weight(kg)	CV
RS-20	3/4"	140	120	1.5	4
RS-25	1"	170	165	2.2	7.5

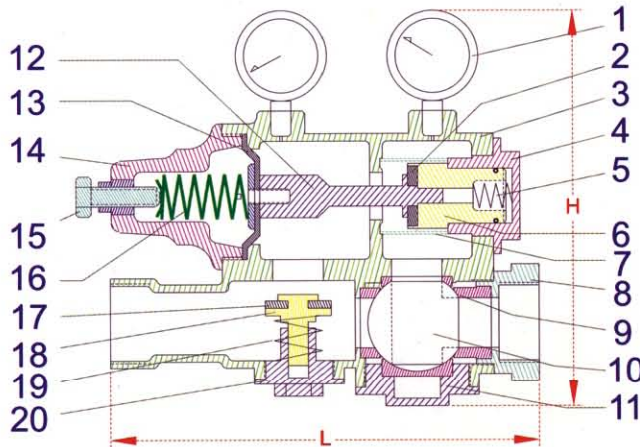

- ▶ Adjustment range : 0.5~5 kgf/cm<sup>2</sup>
- ▶ Applied temperature : -15~70°C
- ▶ Test pressure for valve body : 21 kgf/cm<sup>2</sup>
- ▶ The inlet pressure gauge indicates pressure before reducing, and outlet pressure gauge indicates pressure after reducing.
- ▶ When cleaning the impurities on the filter net, just take off the cylinder (component 4), then filter net (component 7) can be unloaded at the same time.

No	Part Name	Material
1	Pressure meter	Upon request
2	Sealing	NBR
3	Main body	Bronze
4	Cylinder	Bronze
5	Buffer spring	Stainless Steel
6	Piston	Bronze
7	Filter net	Stainless Steel
8	Pipe connector	Bronze
9	PE washer	PE
10	Three-way ball	Brass
11	Nut	Bronze
12	Shaft	Bronze
13	Diaphragm	Fabrics NBR
14	Spring housing	Polyamide 66
15	Adjusting stem	Stainless Steel
16	Pressure spring	Stainless Steel
17	Sealing	NBR
18	Sealing retainer	Brass
19	Spring	Stainless Steel
20	Orientation seat	Bronze

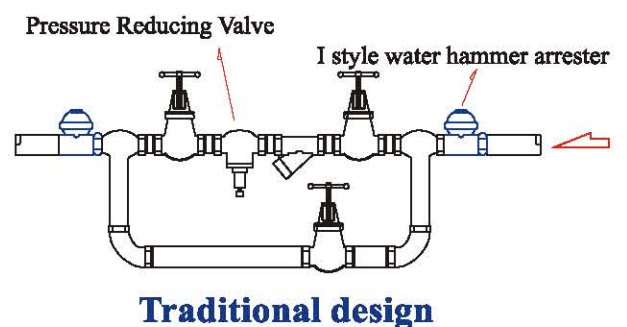
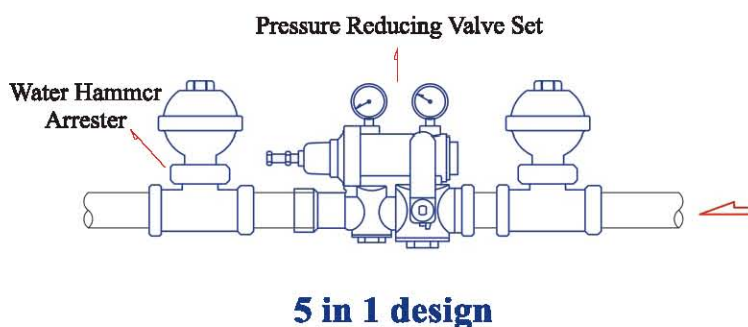

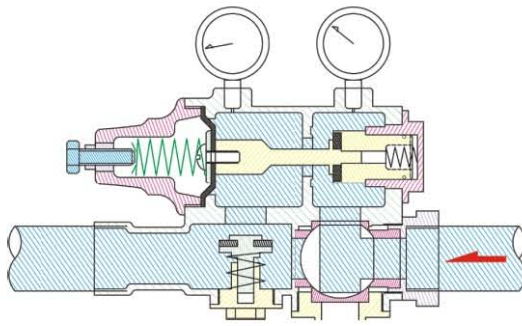

Open state

**ON**



When the handle is rotated upward, pressure reducing valve set becomes pressure reducing open state.

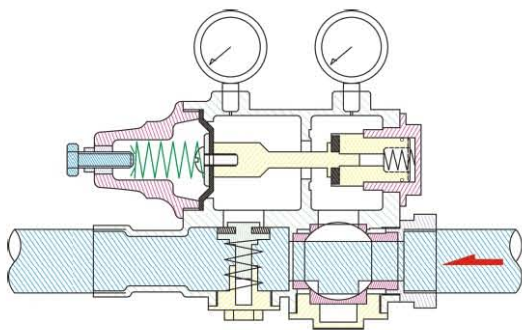

Bypass open state

**PASS**

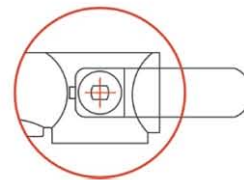

When the handle is rotated to horizontal position, pressure reducing valve set becomes bypass open state.

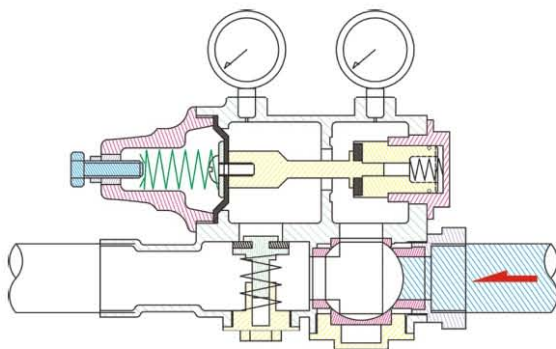

Closed state

**OFF**



When the handle is rotated downward, pressure reducing valve set becomes pressure reducing closed state.